

- > **Port size: 1/4" ... 1/2" (ISO G/PTF)**
- > **Excelon design allows in-line installation or modular installation with other Excelon products**
- > **High efficiency water and particle removal**
- > **Quick release bayonet bowl**
- > **Push to lock adjusting knob with tamper resistant accessory**



Technical features

Medium:

Compressed air only

Maximum operating pressure:

Transparent bowl: 10 bar (145 psi)

Pressure range:

0,3 ... 10 bar (4 ... 145 psi)

Filter element:

40 µm standard

Port size:

G1/4, G3/8, G1/2

Gauge port:

Rc 1/8

Relieving:

Standard

Drain:

Manual or automatic

Automatic drain operating conditions (float operated):

Bowl pressure required to close drain: > 0,3 bar (5 psi)

Bowl pressure required to open drain: ≤ 0,2 bar (2.9 psi)

Minimum air flow required to close drain: 0,1 dm³/s (0.2 scfm)

Manual operation: depress pin inside drain outlet to drain bowl

Ambient/Media temperature:

Transparent bowl:

-20 ... +50°C (-4 ... +122°F)

Air supply must be dry enough to avoid ice formation at temperatures below +2°C (+35°F).

Materials:

Body: Die cast aluminium

Bowl: Transparent PC

Elastomers: CR & NBR

Please contact IMI Norgren for following options:

Operation pressure:

Metal bowl: 17 bar (246 psi)

Pressure range:

0,3 ... 4 bar (4 ... 58 psi)

0,7 ... 17 bar (2 ... 250 psi)

Port size:

1/4 PTF, 3/8 PTF 1/2 PTF

Filter element:

5 µm

Ambient/Media temperature:







Metal bowl:

-34 ... +80°C (-30 ... +176°F)

Technical data BL73 (Filter/Regulator, Lubricator and Gauge) - standard models



Symbol	Port size	Size	Pressure range (bar)	Element (µm)	Drain	Lubricator	Mounting	Shut-off valve	Model
	G1/4	—	0,3 ... 10	40	Automatic	Micro fog	Quikclamp with wall bracket®	With	BL73-201G
	G3/8	Basic	0,3 ... 10	40	Automatic	Micro fog	Quikclamp with wall bracket®	With	BL73-301G
	G1/2	—	0,3 ... 10	40	Automatic	Micro fog	Quikclamp with wall bracket®	With	BL73-401G
	G1/4	—	0,3 ... 10	40	Automatic	Oil fog	Quikclamp with wall bracket®	With	BL73-211G
	G3/8	Basic	0,3 ... 10	40	Automatic	Oil fog	Quikclamp with wall bracket®	With	BL73-311G
	G1/2	—	0,3 ... 10	40	Automatic	Oil fog	Quikclamp with wall bracket®	With	BL73-411G
	G1/4	—	0,3 ... 10	40	Automatic	Micro fog	Quikclamp with wall bracket®	Without	BL73-205G
	G3/8	Basic	0,3 ... 10	40	Automatic	Micro fog	Quikclamp with wall bracket®	Without	BL73-305G
	G1/2	—	0,3 ... 10	40	Automatic	Micro fog	Quikclamp with wall bracket®	Without	BL73-405G
	G1/4	—	0,3 ... 10	40	Automatic	Oil fog	Quikclamp with wall bracket®	Without	BL73-215G
	G3/8	Basic	0,3 ... 10	40	Automatic	Oil fog	Quikclamp with wall bracket®	Without	BL73-315G
	G1/2	—	0,3 ... 10	40	Automatic	Oil fog	Quikclamp with wall bracket®	Without	BL73-415G
	G1/4	—	0,3 ... 10	40	Manual	Micro fog	Quikclamp with wall bracket®	With	BL73-221G
	G3/8	Basic	0,3 ... 10	40	Manual	Micro fog	Quikclamp with wall bracket®	With	BL73-321G
	G1/2	—	0,3 ... 10	40	Manual	Micro fog	Quikclamp with wall bracket®	With	BL73-421G
	G1/4	—	0,3 ... 10	40	Manual	Oil fog	Quikclamp with wall bracket®	With	BL73-231G
	G3/8	Basic	0,3 ... 10	40	Manual	Oil fog	Quikclamp with wall bracket®	With	BL73-331G
	G1/2	—	0,3 ... 10	40	Manual	Oil fog	Quikclamp with wall bracket®	With	BL73-431G
	G1/4	—	0,3 ... 10	40	Manual	Micro fog	Quikclamp with wall bracket®	Without	BL73-225G
	G3/8	Basic	0,3 ... 10	40	Manual	Micro fog	Quikclamp with wall bracket®	Without	BL73-325G
	G1/2	—	0,3 ... 10	40	Manual	Micro fog	Quikclamp with wall bracket®	Without	BL73-425G
	G1/4	—	0,3 ... 10	40	Manual	Oil fog	Quikclamp with wall bracket®	Without	BL73-235G
	G3/8	Basic	0,3 ... 10	40	Manual	Oil fog	Quikclamp with wall bracket®	Without	BL73-335G
	G1/2	—	0,3 ... 10	40	Manual	Oil fog	Quikclamp with wall bracket®	Without	BL73-435G

Accessories

<p>Quikclamp®</p>  <p>Page 3</p> <p>4314-51</p>	<p>Quikclamp with wall bracket®</p>  <p>Page 3</p> <p>4314-52</p>	<p>Tamper resistant kit</p>  <p>4455-51</p>	
<p>Quikmount pipe adaptor *1)</p>  <p>Page 3</p> <p>G1/4: 4315-09 G3/8: 4315-10 G1/2: 4315-11</p>	<p>Porting block with three alternative 1/4" ports</p>  <p>Page 3</p> <p>G1/4: 4316-52 1/4 PTF: 4316-50</p>	<p>2/2 Shut-off valves (for full technical specification see datasheet 8.180.600)</p>  <p>Page 4</p> <p>G1/4: T73B-2GA-P1N G3/8: T73B-3GA-P1N G1/2: T73B-4GA-P1N</p>	<p>3/2 Shut-off valves (for full technical specification see datasheet 8.180.600)</p>  <p>Page 4</p> <p>G1/4: T73T-2GA-P1N G3/8: T73T-3GA-P1N G1/2: T73T-4GA-P1N</p>

*1) Please use a Quikmount pipe adaptor if the Quikclamp be mounted at inlet or outlet side.

Pressure switch

<p>Porting block for pressure switch</p>  <p>Page 3</p> <p>0523110000000000</p>	<p>Pressure switch (0,5 ... 8 bar)</p>  <p>0881300000000000</p>	<p>Padlock (brass) with two keys *1)</p>  <p>0613633000000000</p>
--------------------------------------------------------------------------------------------------------------------------------------------------------------------------	----------------------------------------------------------------------------------------------------------------------------------------------------------	------------------------------------------------------------------------------------------------------------------------------------------------------------

*1) for shut-off valves

Gauge

Center back connection, white face (for full technical specification see datasheet 8.900.900)



Pressure range bar *1	Mpa	psi	Ø	Thread size	Model
0 ... 4	0 ... 0,4	0 ... 58	50 mm	R1/8	18-013-011
0 ... 10	0 ... 1	0 ... 145	50 mm	R1/8	18-013-013
0 ... 25	0 ... 2,5	0 ... 362	50 mm	R1/8	18-013-014

*1) primary scale

Drawing

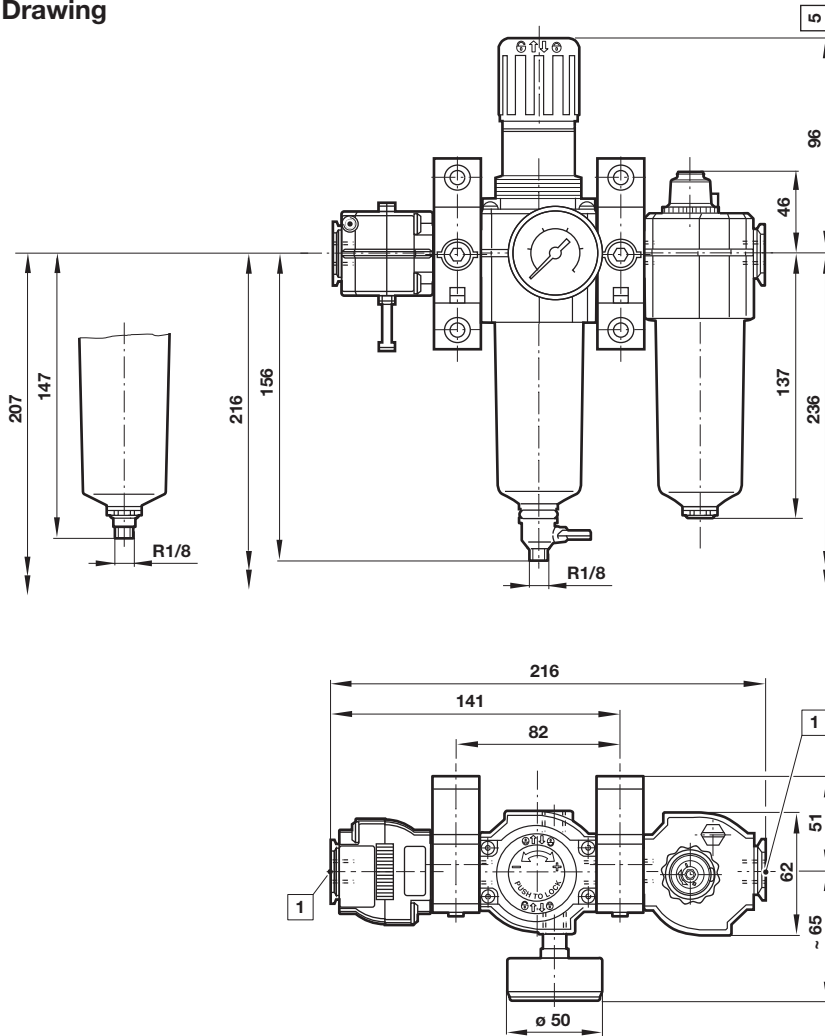

Dimensions in mm
 Projection/First angle



Minimum clearance required to remove bowl

- 1 Main ports 1/4", 3/8" or 1/2"
- 3 Transparent bowl
- 5 Reduces by 4 mm with knob in locked position

Accessories

Quikclamp®

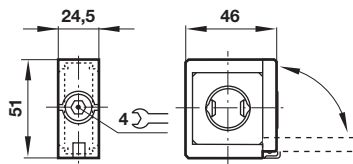

Quikclamp® with wall bracket

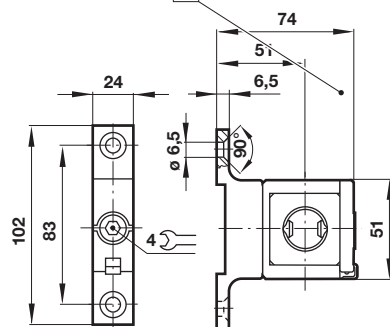

Porting block

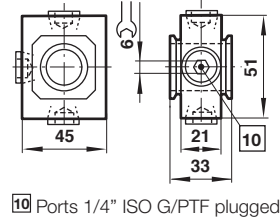

Pipe adapter

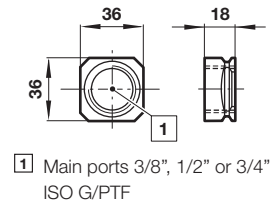

- 1 Main ports 3/8", 1/2" or 3/4" ISO G/PTF

- 10 Ports 1/4" ISO G/PTF plugged

Shut-off valves

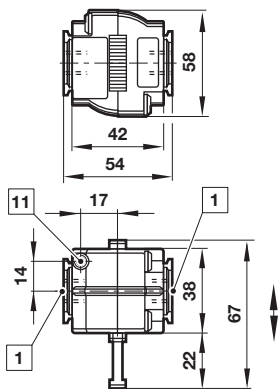

- 1 Main ports 1/4", 3/8" or 1/2" ISO G/PTF
- 11 Exhaust port M5 at 3/2 valve only

Porting block for pressure switch

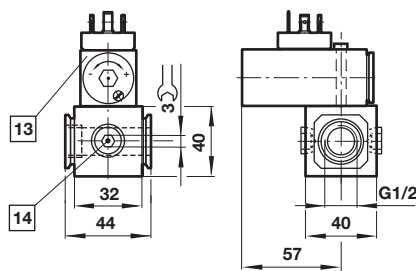

- 13 Pressure switch is not in scope of delivery
- 14 Alternative G1/4 ports plugged

Dimensions in mm
 Projection/First angle



Warning

These products are intended for use in industrial compressed air systems only. Do not use these products where pressures and temperatures can exceed those listed under »**Technical features/data**«.

Before using these products with fluids other than those specified, for non-industrial applications, life-support systems or other applications not within published specifications, consult IMI Precision Engineering, Norgren Inc. Through misuse, age, or malfunction, components used in fluid power systems can fail in various modes.

The system designer is warned to consider the failure modes of all component parts used in fluid power systems and to provide adequate safeguards to prevent personal injury or damage to equipment in the event of such failure.

System designers must provide a warning to end users in the system instructional manual if protection against a failure mode cannot be adequately provided.

System designers and end users are cautioned to review specific warnings found in instruction sheets packed and shipped with these products.